

The design is created to accept the flood for what it is rather than the dread it currently portrays. This building will encourage collaboration between multiple government agencies to provide increased teamwork and productivity. By using investigative dissection of the habits that are set in place in the past, the health center will reunite effective strategies to benefit the town further into the future.

the Walsenburg Center

kristina artyushkevich + sarah vanderpool

SITE PLAN LEGEND

- 1 RUNNING PATH AND WATER DIVERSION
- 2 LANDSCAPED SEATING
- 3 CHILDREN PLAYGROUND
- 4 TERRACED GARDEN
- 5 GREENROOF
- 6 GLASS ATRIUM
- 7 EXTERIOR PATIO
- 8 ROOFTOP MEDITATION DECK
- 9 EXTERIOR BOARDWALK
- 10 OUTDOOR SEATING AREA
- 11 SENIOR WALKING PARK
- 12 EXTERIOR DECK
- 13 PARKING LOT

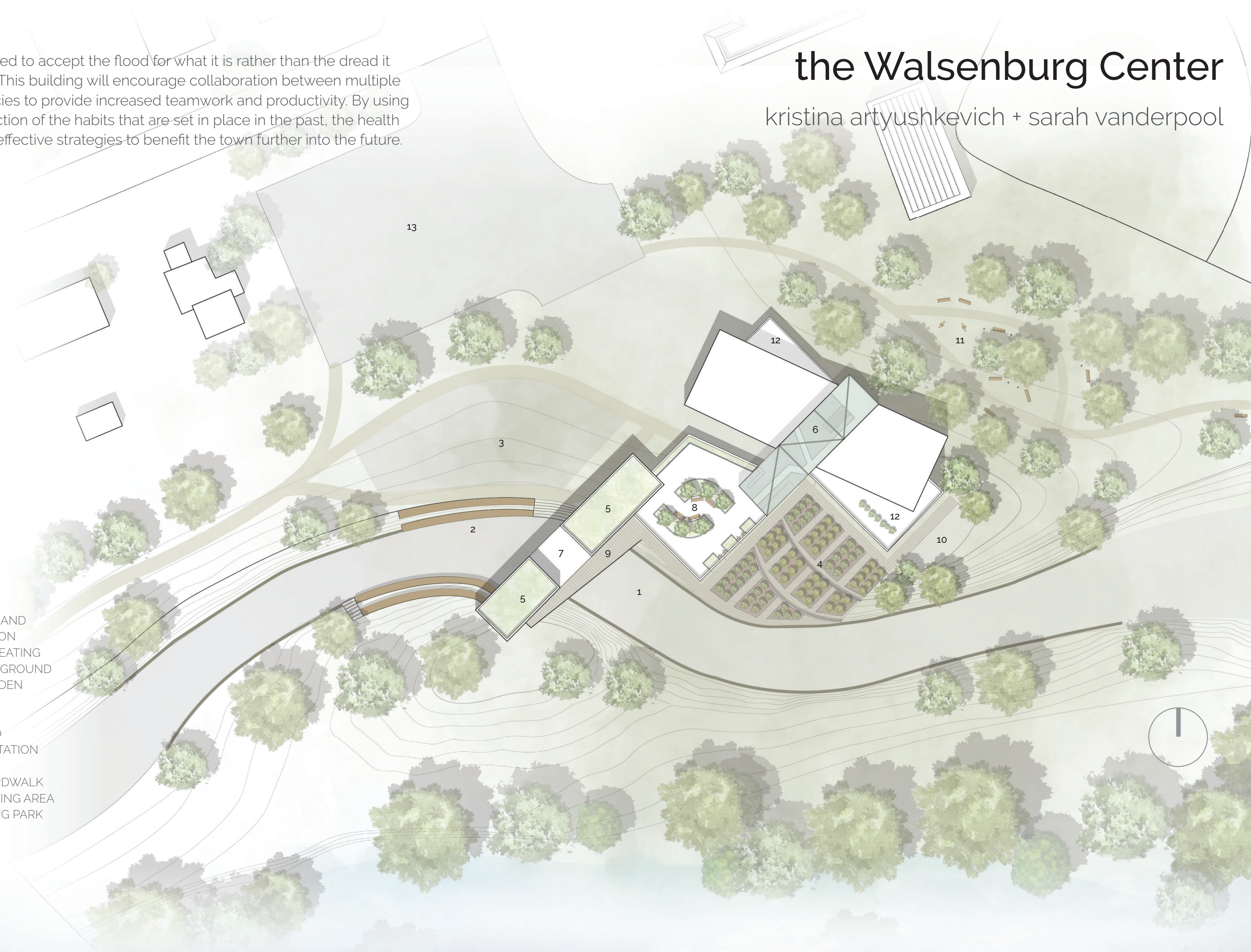

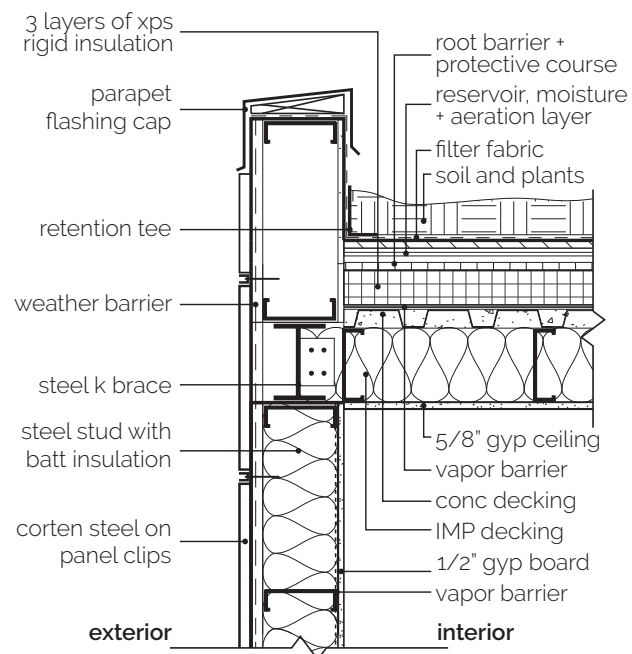

RECREATION: GREENROOF

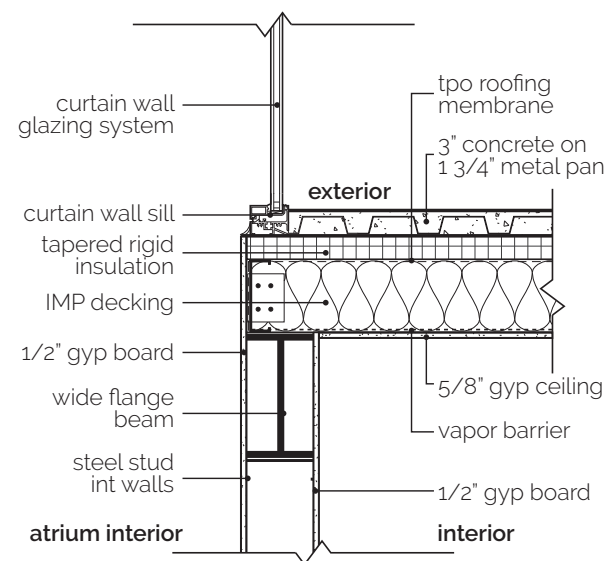

CLINIC: ATRIUM GLASS TO FLOOR

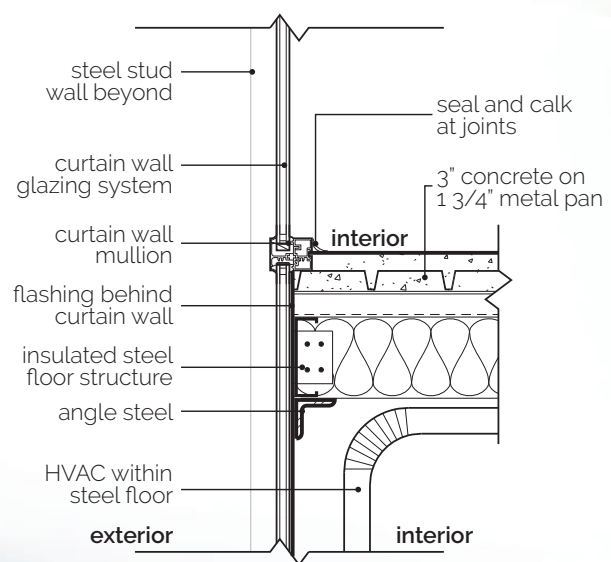

OFFICE: GLASS ABUTTING FLOOR

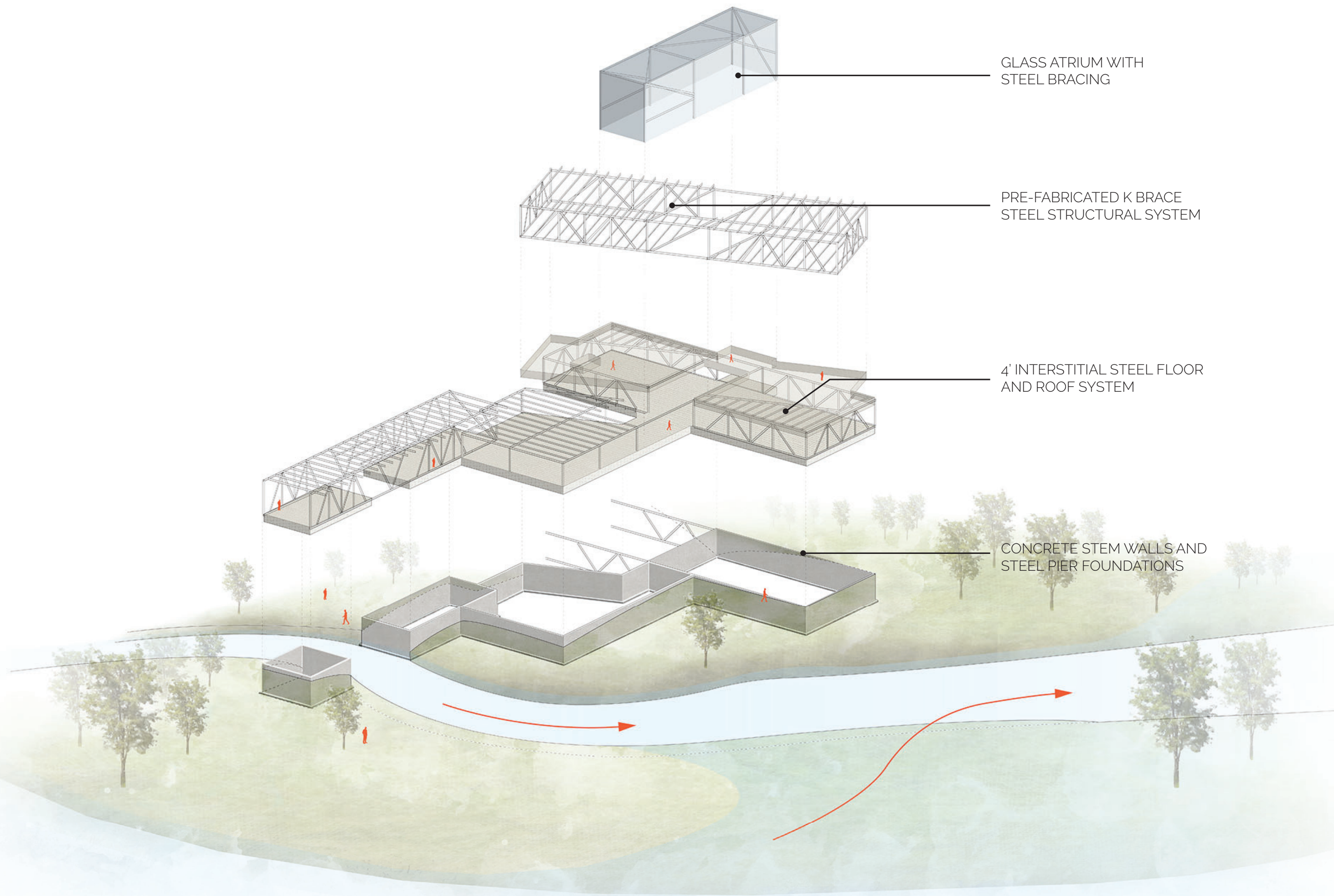



ATRIUM LOOKING AT BRIDGE



LOBBY AND HARVEST WALL



SECOND LEVEL CIRCULATION

FIRST FLOOR LEGEND

- 1 EDUCATIONAL KITCHEN
- 2 BATHROOMS
- 3 PANTRY
- 4 EXTERIOR PATIO
- 5 EARLY CHILDHOOD OFFICE
- 6 STORAGE
- 7 FIRE STAIRCASE
- 8 OFFICE BREAK ROOM
- 9 WAITING ROOM
- 10 PRIVATE OFFICE
- 11 CONFERENCE ROOM
- 12 BEHAVIORAL HEALTH OFFICE
- 13 DEVELOPMENTAL HEALTH
- 14 LOBBY/ATRIUM
- 15 TWO STORY HARVEST WALL
- 16 PUBLIC HEALTH OFFICE
- 17 ER SUPPLY/VITAL RECORD STORAGE
- 18 ELEVATOR
- 19 MECHANICAL/STORAGE
- 20 PUBLIC HEALTH EXAM ROOM
- 21 PHYSICAL THERAPY

SECOND FLOOR LEGEND

- 1 CONFERENCE ROOM
- 2 WAITING ROOM
- 3 FIRE STAIRCASE
- 4 LARGE TREATMENT ROOM
- 5 SMALL TREATMENT ROOM
- 6 IMMUNIZATION AREA
- 7 OPEN AIR BRIDGE
- 8 TWO STORY HARVEST WALL
- 9 ROOFTOP MEDITATION DECK
- 10 ELEVATOR
- 11 MECHANICAL
- 12 MENS RESTROOM
- 13 WOMENS RESTROOM
- 14 CASE FILE STORAGE
- 15 EXAM ROOM
- 16 TRIAGE ROOM AND LAB
- 17 MEDITATION SPACE
- 18 ROOFTOP DECK
- 19 GREENROOF
- 20 JANITORS CLOSET

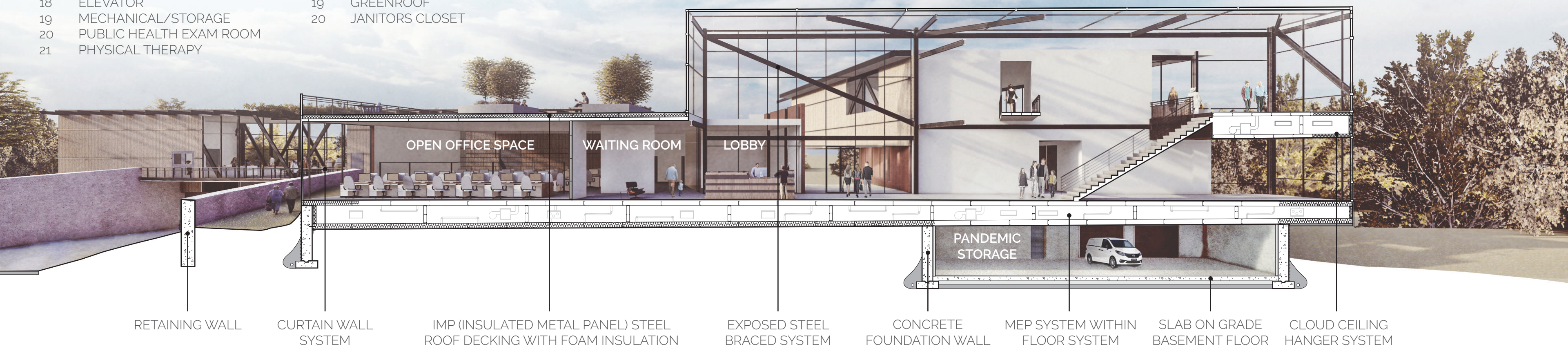

RETAINING WALL

CURTAIN WALL SYSTEM

IMP (INSULATED METAL PANEL) STEEL ROOF DECKING WITH FOAM INSULATION

EXPOSED STEEL BRACED SYSTEM

CONCRETE FOUNDATION WALL

MEP SYSTEM WITHIN FLOOR SYSTEM

SLAB ON GRADE BASEMENT FLOOR

CLOUD CEILING HANGER SYSTEM

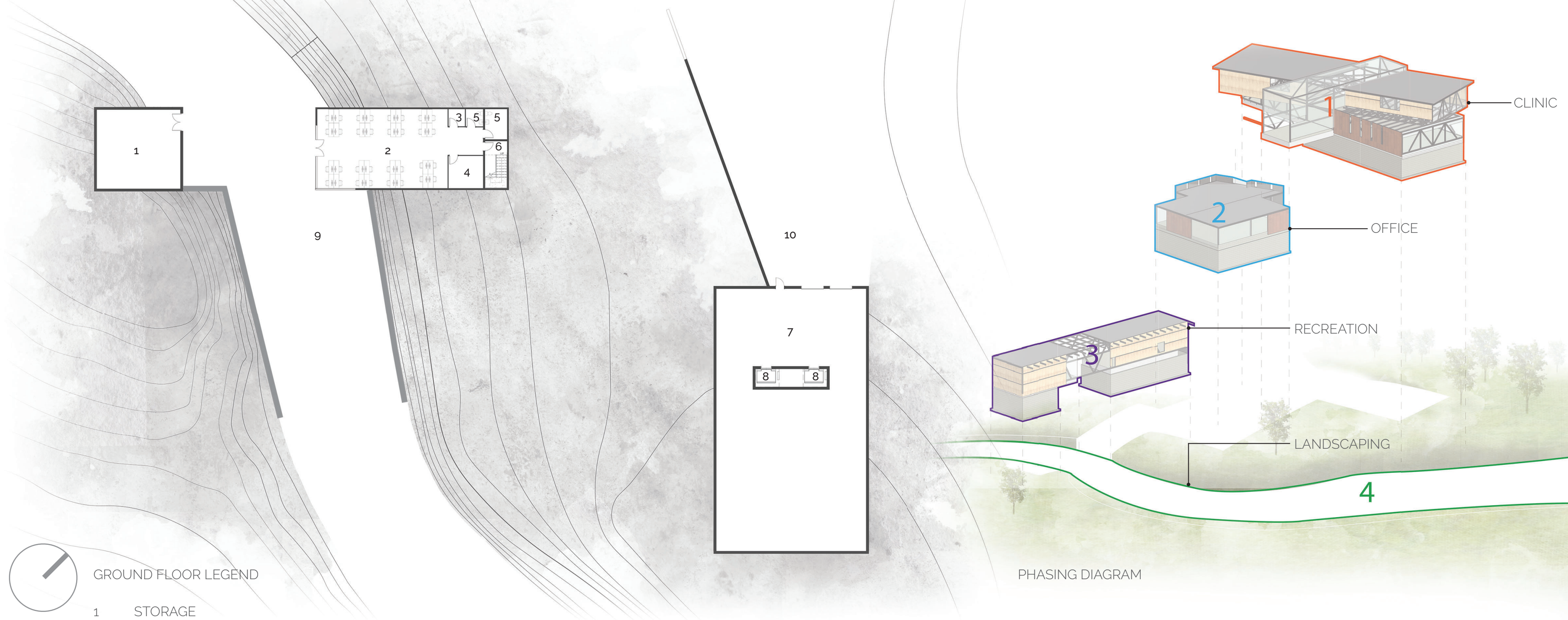

- GROUND FLOOR LEGEND
- 1 STORAGE
 - 2 SOCIAL SERVICES
 - 3 JANITORS CLOSET
 - 4 FILE STORAGE
 - 5 BATHROOM
 - 6 FIRE STAIRCASE
 - 7 PANDEMIC STORAGE AND LOADING DOCK
 - 8 ELEVATOR
 - 9 RUNNING PATH AND WATER DIVERSION
 - 10 PANDEMIC STAGING

